



RETRACTABLE TARPS P/L

TARPING SYSTEMS & COMPONENTS

ACN 069 575 711 ABN 34 069 575 711

DC SERIES OWNERS MANUAL

CONTENTS

DC SERIES OWNERS MANUAL.....	i
FIGURES.....	ii
TABLES.....	ii
ARMLESS SYSTEMS.....	1
TO COVER THE CONTAINER	1
TO UNCOVER CONTAINER.....	3
SYSTEM MAINTENNANCE	5
GENERAL RECOMMENDATIONS	5
ROLL RITE "BLACK BOX" TROUBLESHOOTING	5
LED DIAGNOSTICS	5
Unit at Rest	5
Unit in Operation	5
FUSE REPLACEMENT	6
APPLICATION PROGRAMING	7
KEYFOB PROGRAMING.....	7
LOCK OUT FEATURE	8
SYSTEM WIRING DIAGRAM.....	9
QUICK REFERENCE GUIDE	10
BLACK BOX OPERATION	10
LOCK OUT FEATURE	10

FIGURES

Figure 1: Power Up/Down Procedure 1
 Figure 2: Raising Tower Procedure 1
 Figure 3: Tarp Deployment Procedure..... 2
 Figure 4: Tarp Lowering Procedure..... 2
 Figure 5: Tightening Procedure..... 3
 Figure 6: Tarp Loosening Procedure 3
 Figure 7: Raising Tower Procedure 3
 Figure 8: Tightening Procedure..... 4
 Figure 9: Home Procedure 4
 Figure 10: Fuse Position in the Control Unit 6
 Figure 11: Keyfob Programming Procedure..... 7
 Figure 12: lockout Time Selection..... 8
 Figure 13: Complete System Wiring Diagram 9

TABLES

Table 1: LED Indicators at rest 5
 Table 2: Unit LED Operation Indicators 5
 Table 3: Application based Programs 7

**ARMLESS SYSTEMS
TO COVER THE CONTAINER**

1. On all systems with remote operation, you must first turn on the control box. To activate (Power up or down) the control box you must press and hold one and two on the control unit or keyfob (Figure 1). Non remote systems are always active.

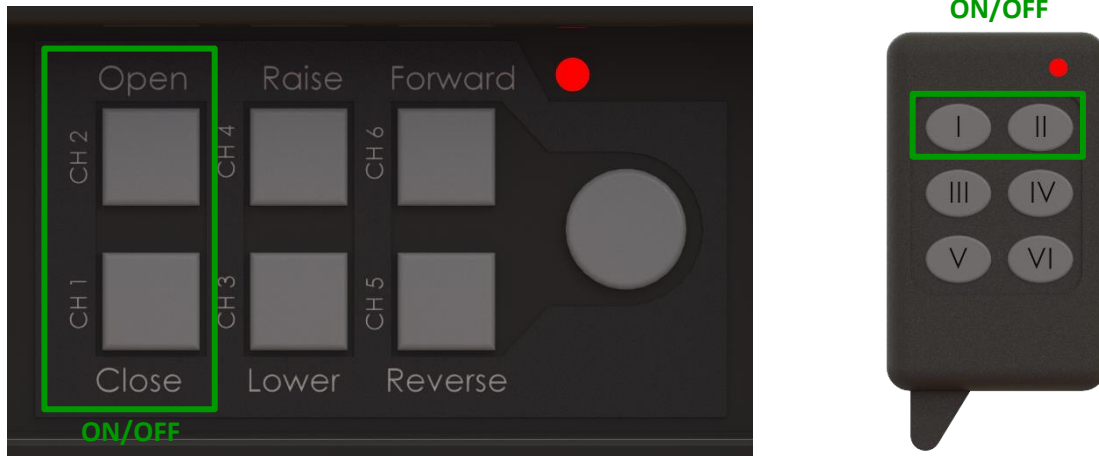

Figure 1: Power Up/Down Procedure

2. Raise the tower as high as possible to keep the tarp from dragging on the load in the container below. To raise the tower, press and hold button 4 on the control box or keyfob.

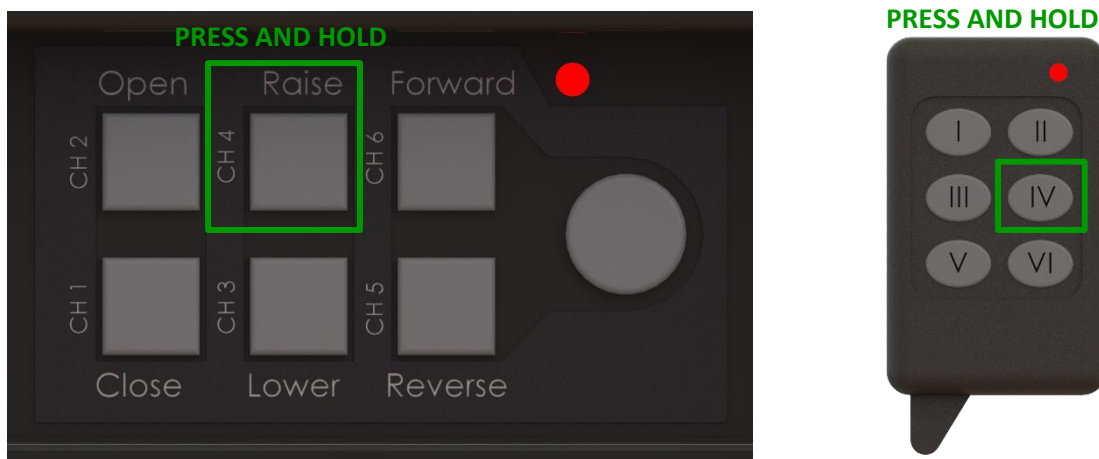

Figure 2: Raising Tower Procedure

3. Deploy tarp and walk to the rear of the container. To deploy tarp, press and hold button 1 on the control box or keyfob (Figure 3), or on non-remote systems the manual switch to wind and unwind the tarp. In rare cases with stationary pivot systems, you may have to do this before pulling the container all the way onto the truck/trailer.

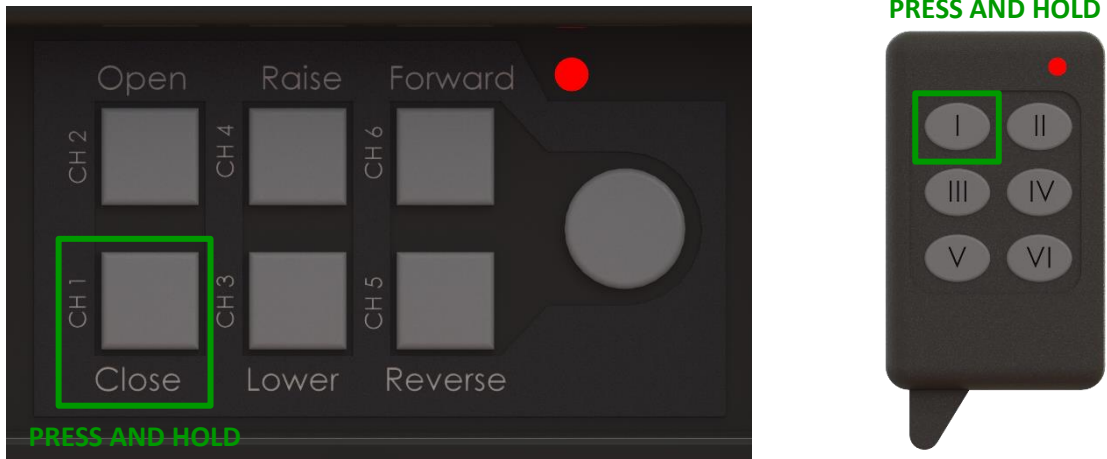

Figure 3: Tarp Deployment Procedure

4. Secure the tarp at the rear of the container.
5. Lower the tower by pressing and holding button 3 on either the control box or keyfob.

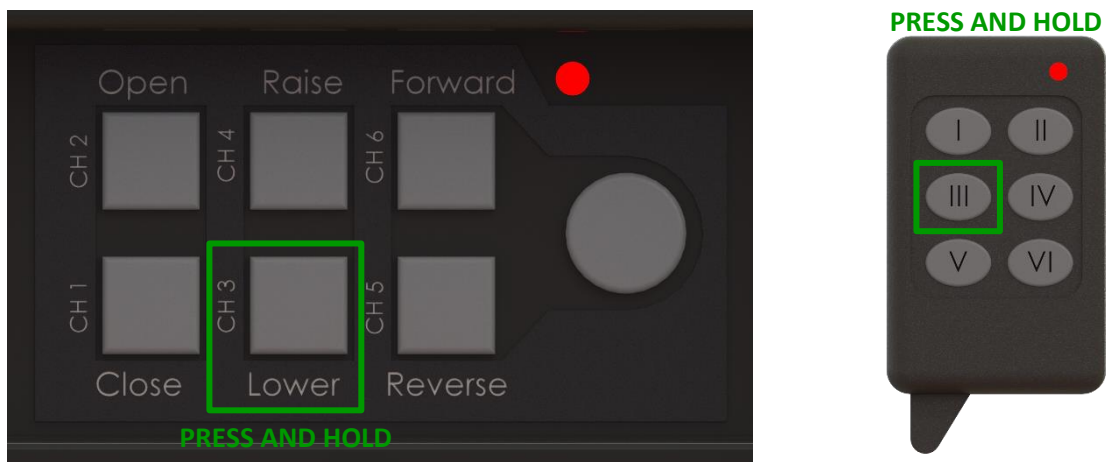

Figure 4: Tarp Lowering Procedure

- Tighten the tarp by pressing and holding button 2 on either the control box or keyfob.

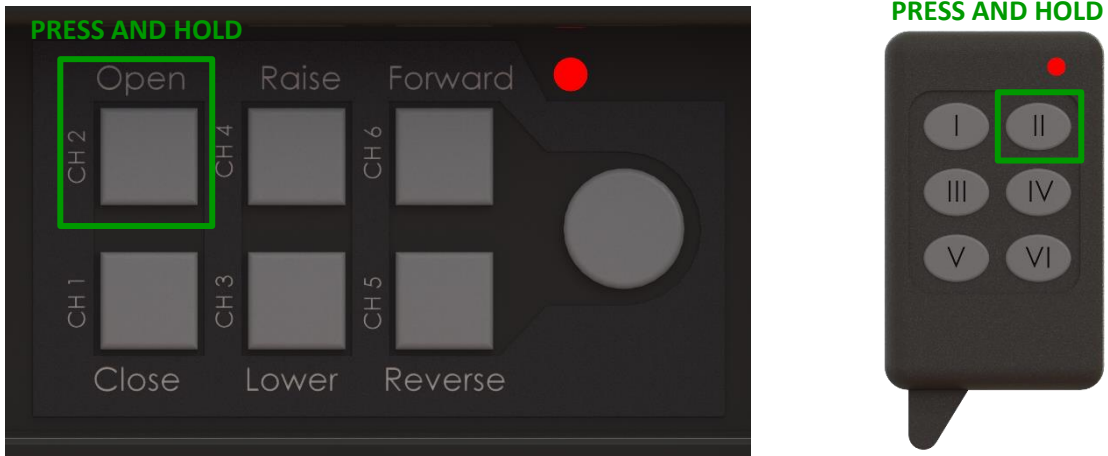

Figure 5: Tightening Procedure

TO UNCOVER CONTAINER

- Loosen the tarp, uncoil several feet of tarp. OT loosen the tarp, press and hold button 1 on the control box or the keyfob.

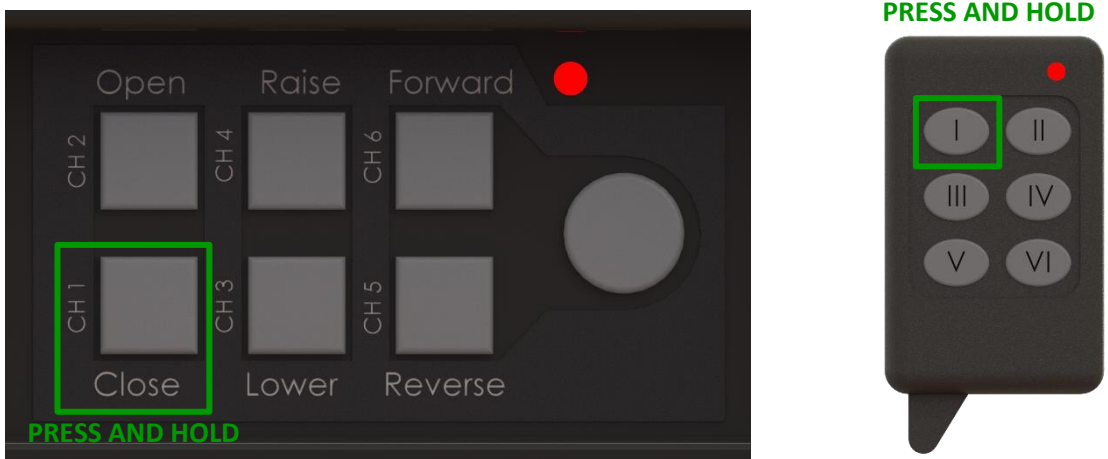

Figure 6: Tarp Loosening Procedure

- Raise the tower as high as possible to keep the tarp from dragging on the load in the container below. To raise the tower, press and hold button 4 on the control box or keyfob.

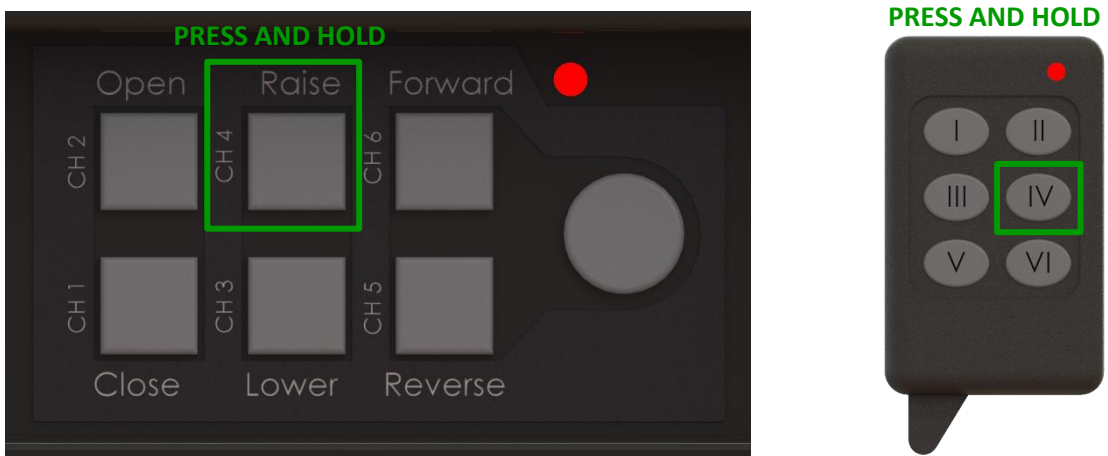

Figure 7: Raising Tower Procedure

- Walk the tarp in as you wind it. To wind the tarp, press and hold button 2 on the control box or keyfob.

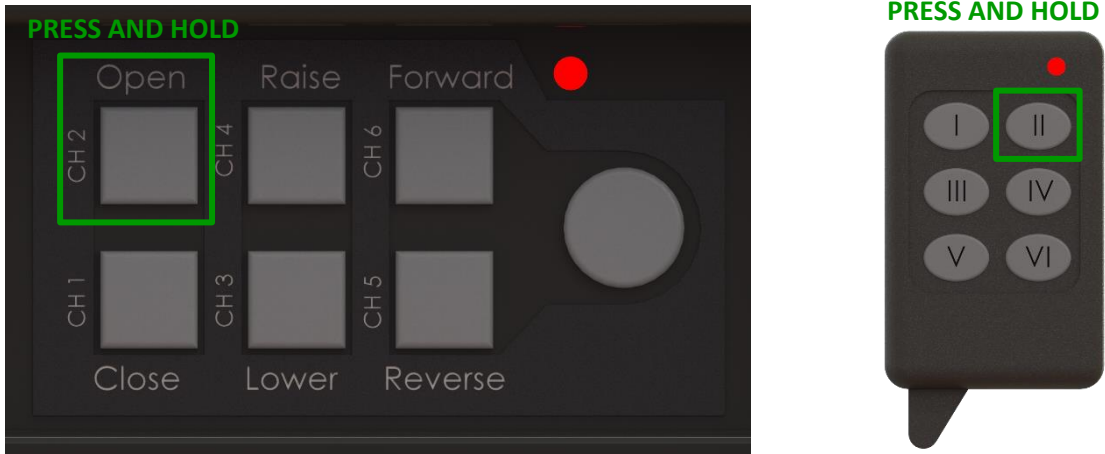
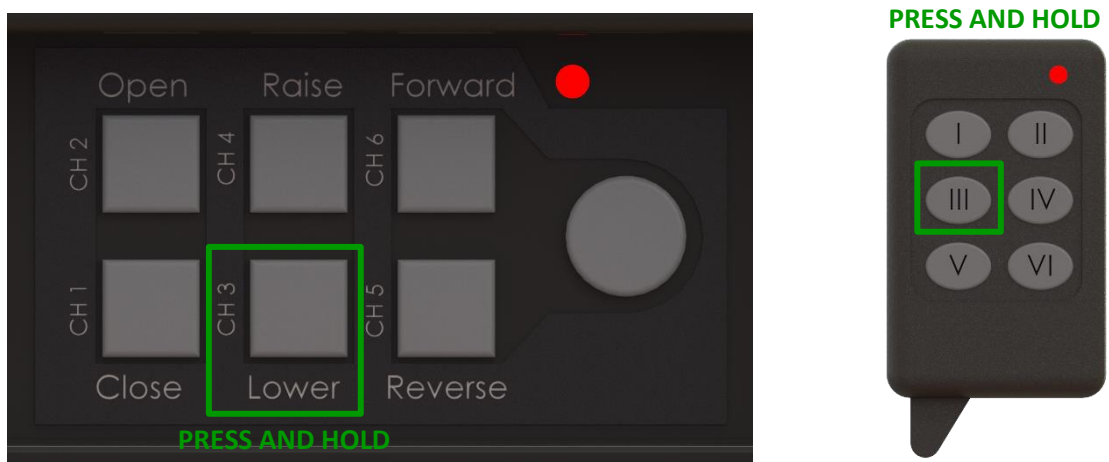

Figure 8: Tightening Procedure

- Unload or dump container, if you are traveling with an empty or no container return the system to its home position. Home position is typically with the tower fully lowered. To lower the system, press and hold button 3 or the control box or keyfob.



SYSTEM MAINTENNANCE

GENERAL RECOMMENDATIONS

- All electrical connections should be cleaned and greased regularly to prevent corrosion (Fill all electrical boots, limit switch boots, etc. with dielectric grease). Electrical connections can be found on all motors, witches, contactors, limit switches, control boxes and batteries.
- All bearings with grease fittings and tower legs must be greased regularly.
- Check and tensions all set screws. Set screws should be tightened until they touch and then torqued $\frac{3}{4}$ of a revolution beyond that.
- Check motor mounting bolts and torque to 70 in-lbs (5.8 ft-lbs).
- All mounting hardware should be checked to ensure all system components are securely fastened.
- Visually inspect all moving parts for abnormal or excessive wear.

ROLL RITE “BLACK BOX” TROUBLESHOOTING

LED DIAGNOSTICS

Unit at Rest

Table 1: LED Indicators at rest

No Light	N/A	No power or box is locked out (See lock out feature)
Green	Continuous	Everything is ok
Green	Single Blink	Low Battery warning
Green	Double Blink	Battery is nearly dead (will not operate until recharged)
Yellow	Continuous	Fuse 1 (5 Amp Figure 10) Blown
Yellow	Single Blink	Fuse 2 (10 Amp Figure 10) Blown
Yellow	Double Blink	Fuse 3 (15 Amp Figure 10) Blown
Yellow	Triple Blink	Fuse 4 (15 Amp Figure 10) Blown
Red	Continuous	Unit in Program Mode

Unit in Operation

Table 2: Unit LED Operation Indicators

Red	Continuous	Confirms it is operation
Red	Single Blink	Low Battery Warning
Red	Double Blink	Battery is nearly dead (will not operate until recharged)

FUSE REPLACEMENT

1. Using the above codes, diagnose which fuse has blown
2. Remove the 10 bolts that hold the lid in place
3. Carefully lift the lid and unplug switch leads
4. Do not touch the circuit board any more than necessary
5. Carefully locate (See Figure 10) and remove the blown fuse and replace it
6. Replace the lid and perform the following checks:
 - (a) Plug switch leads in
 - (b) Arrange so that they will not be pinched as the lid is replaced
 - (c) Insure that the gasket is in place in the lid groove
 - (d) Press lid back into place and replace the 10 securing bolts
 - (e) Tighten lid bolts in a star pattern to ensure that the lid is evenly tightened

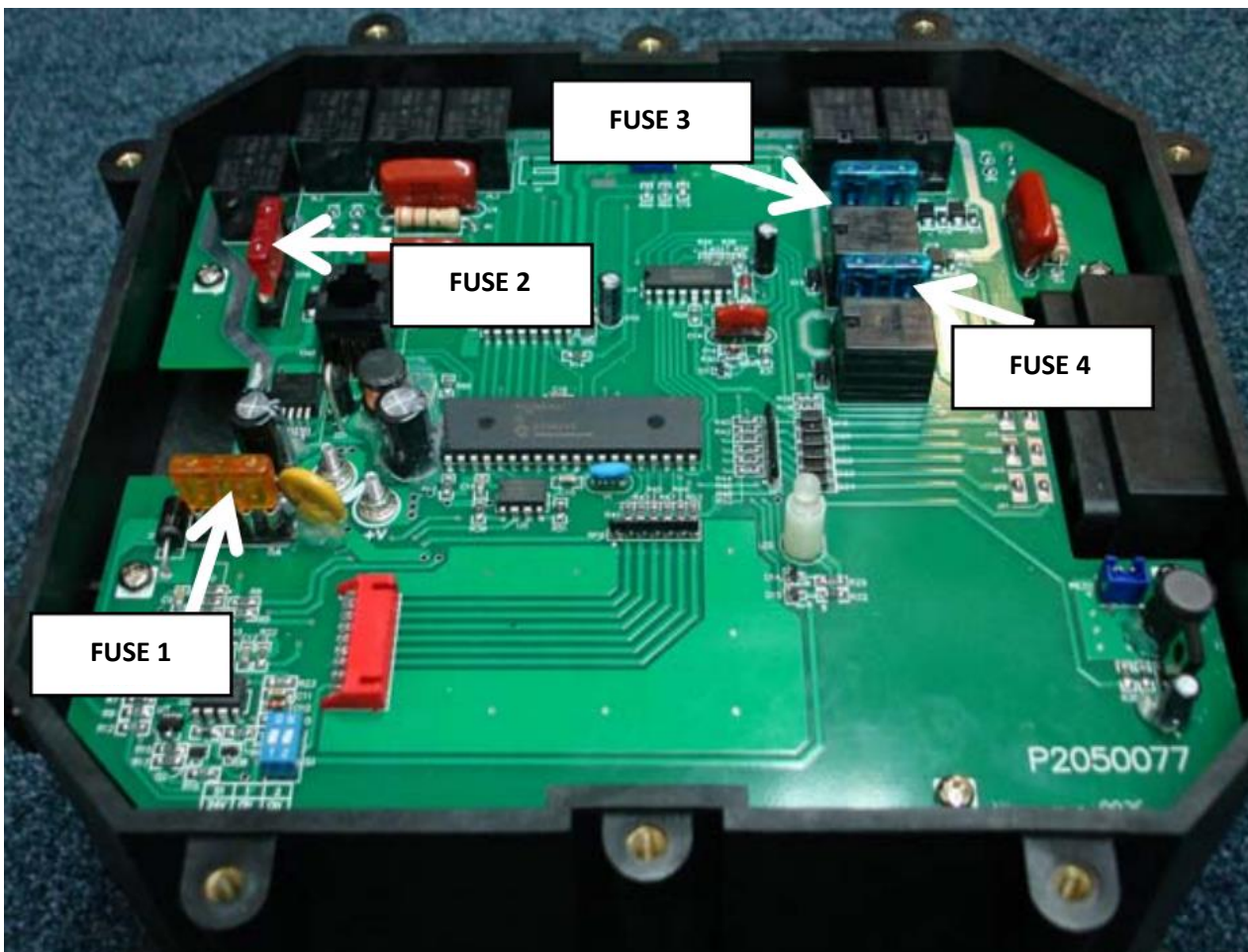

Figure 10: Fuse Position in the Control Unit

APPLICATION PROGRAMING

(For reference only)

All boxes come preprogramed for the application. This unit has 2 programming modes, mode 1 all functions should be off for this type of application. For details on settings in program mode 2, see the application table below for channel settings.

Table 3: Application based Programs

Application	CH 1	CH 2	CH 3	CH 4	CH 5	CH 6
Construction/Ag	Off	On	Off	Off	Off	Off
Waste	Off	On	Off	On	Off	Off

- 1) Confirm that the box is turned on (Status LED should be green)
- 2) Press and release the work light button 6 times within 6 seconds – the green LED will flash 3 times and then change to red.
- 3) Press and release the work light button once more – the LED will flash then return to solid red
- 4) Press and release each channel button to verify the correct setting for each, (see Table 3 for specific settings. The LED will flash green to confirm that the setting is turned on, or flash green twice to indicate that the setting is disabled.
- 5) Wait 8 seconds for the box to exit the programing mode – the LED will turn green.

KEYFOB PROGRAMING

The control box comes preprogramed to the two supplied remote keyfobs. If for any reason you should need to reprogram the remotes, or add any additional keyfobs. Simply follow the procedure below.

- 1) Confirm that the control box is on (Status LED should be green)
- 2) Press and hold the round work light button for 6 seconds (The LED will flash red 3 times to indicate programme mode.
- 3) Press and hold button I (Figure 11) on the first keyfob for 2 seconds then release. Press button I for 2 seconds on each consecutive keyfob that needs to be programmed.
- 4) Let the box stand until the status LED returns too green, completing the process.

The control box will learn a maximum of 4 keyfobs. All keyfobs must be programmed at the same time. Adding additional fobs at a later date will erase the unit's memory and require reprogramming.

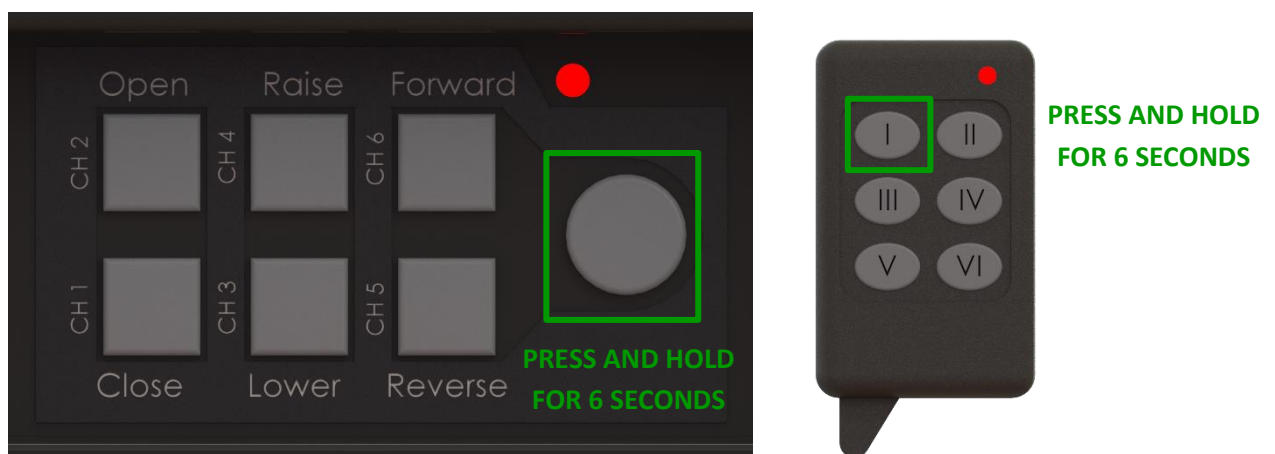

Figure 11: Keyfob Programming Procedure

LOCK OUT FEATURE

The control box incorporates an automatic safety shutoff after 6 minutes* of inactivity. Press buttons 1 and 2 simultaneously on the box or remote for two seconds to power the unit back up. To lock the box down manually, simply press 1 and 2 simultaneously again to shut the unit down.

*Note Boxes produced after 8/10/2009 may feature a programmable time out feature. Adjust this delay before shutoff:

1. Turn the box on
2. Press and release the work light button 6 times, wait until the light stops flashing and press again. The LED will flash once and you are now in programing mode ready to adjust the automatic shutoff feature.
3. Referencing the figure below, the number indicated on the buttons represents the minutes to shut down. In which "0" means it will never shut down automatically.
4. After selecting the shut down time and waiting for the LED to turn green, the programming is complete.



Figure 12: lockout Time Selection

SYSTEM WIRING DIAGRAM

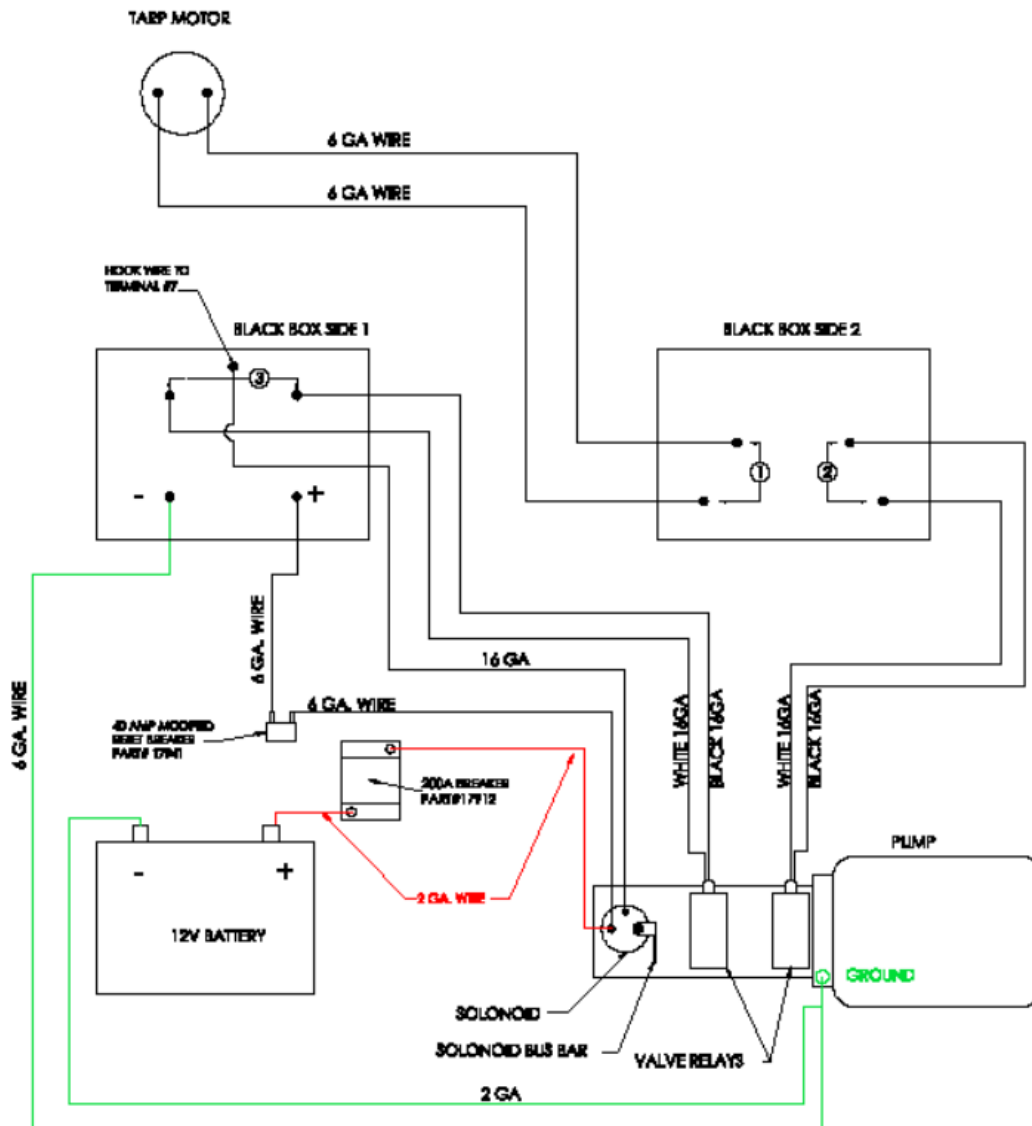

Figure 13: Complete System Wiring Diagram

QUICK REFERENCE GUIDE

(Detach and put in truck)

BLACK BOX OPERATION

- ❖ **ON/OFF** – To turn the control box on or off, press CH1 and CH2 simultaneously for 2 seconds. This can be done from the box itself or keyfob.
- ❖ **Work Light** – If your system is equipped with work lights, turn the control box on and then press the work light button to turn them on/off. Note this is **not** the power on/off for the complete control box.
- ❖ **CH1 and CH2** – Control buttons for output #1 on the control box (typically connected to the tarp motor). These two buttons correspond to buttons I and II respectively on the remote keyfob.
- ❖ **CH3 and CH4** – control buttons for output # 2 on the control box (typically connected to the hopper door or tower up/down). These two buttons correspond with III and IV on the remote keyfob.
- ❖ **CH5 and CH6** – control buttons for output # 3 on the control box (typically connected to the hopper door or sliding pivots). These two buttons correspond with V and VI on the remote keyfob.

LOCK OUT FEATURE

The control box incorporates a programmable safety feature which shuts it off automatically after a given period of inactivity. This feature is programmable, see “Lock Out Feature” section in your operating instructions. Press buttons 1 & 2 simultaneously on the box or remote for two seconds (as described above) to power the unit back up.

To lock the box down manually (shut off), press 1 & 2 simultaneously on the box or remote for two seconds as described above.